

Import the proper Iso-curves into your CAD drawing IES Photometric files B533 Iso curves in footcandles unit: feet

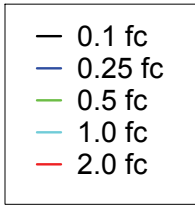

Mounting height 7' no tilt

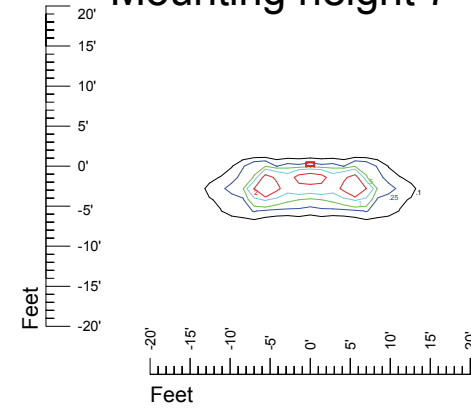

Mounting height 9' no tilt

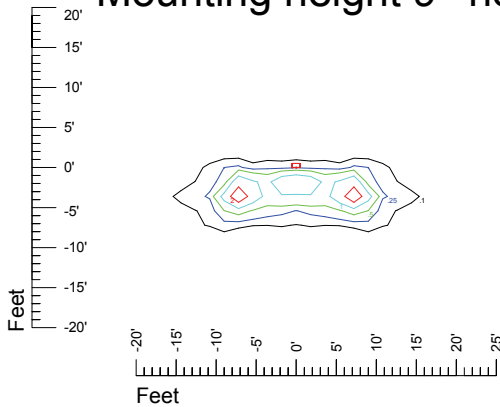

Mounting height 11' no tilt

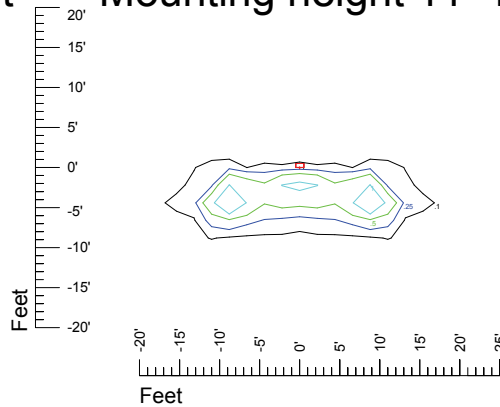

Mounting height 15' no tilt

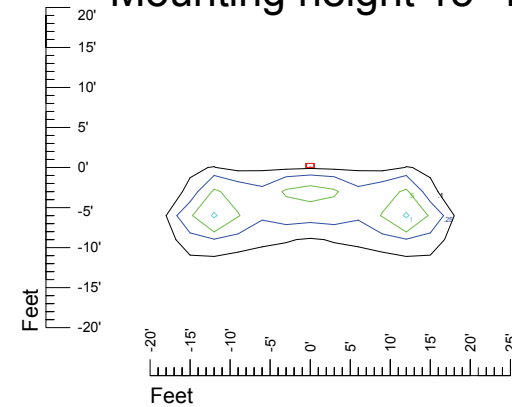

Mounting height 20' no tilt

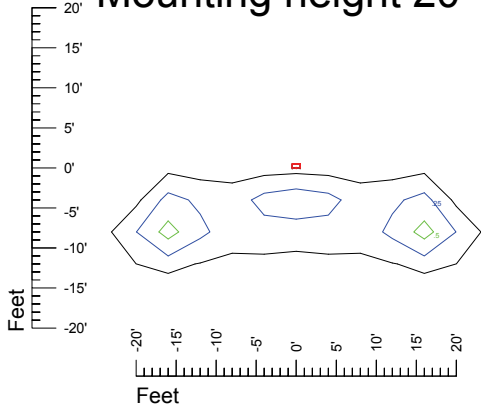

Mounting height 25' no tilt

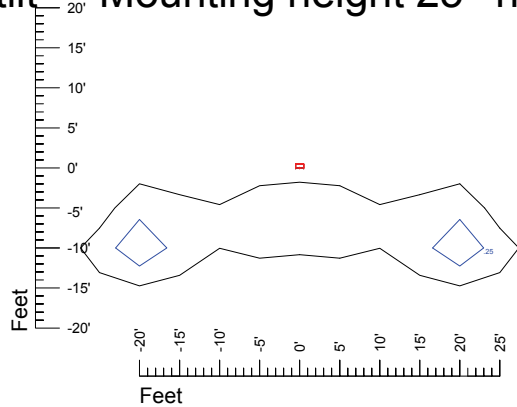

Mounting height 30' no tilt

